



# **Tsubaki Power and Performance** **For the Noodle Making Industry**



# Production Process Instant Noodles

1

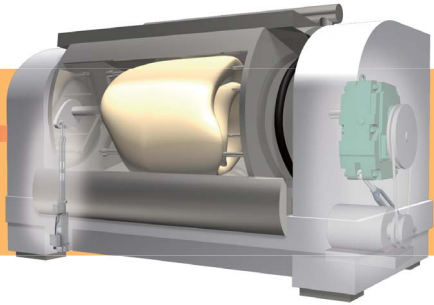

Mixer  
(kneads dough)

Pg. 3

2

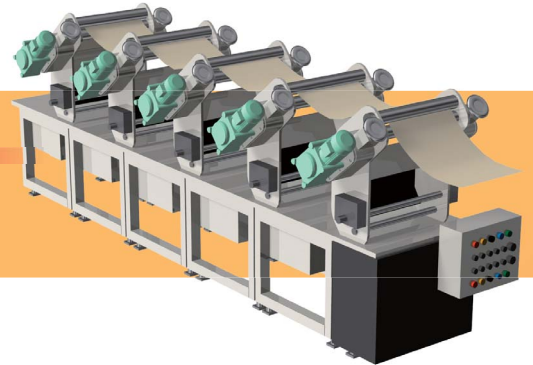

Roller  
(spreads dough into a thin sheet)

Pg. 3

7

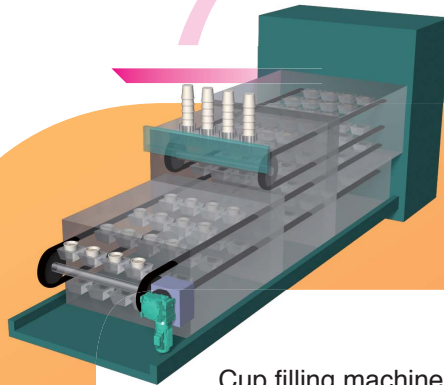

Cup filling machine  
(puts noodles into cups)

Pg. 8

6

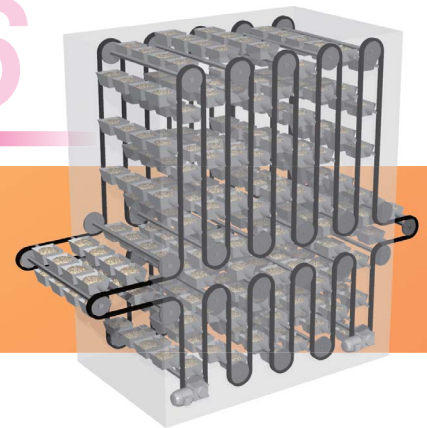

Accumulator

Pg. 7

8



Packer  
(packs cups)

9

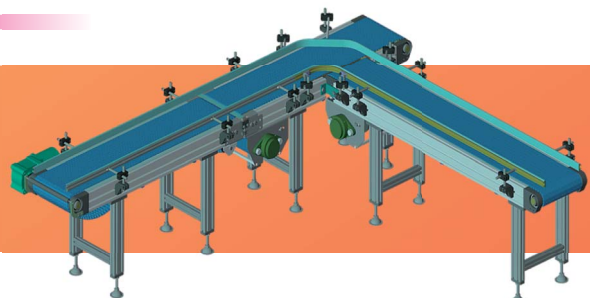

Transfer

Pg. 9

A wide range of processes are used in noodle production lines and many of our products play an important role in those processes.

3

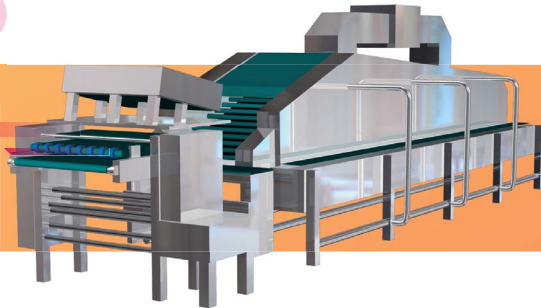

Slitter  
(slits noodles)

4



Steamer  
(steams noodles)

Pg. 4

Fryer and dryer  
(for fried noodles)



Pg. 5

5



Hot air dryer  
(for non-fried noodles)

Pg. 6

10

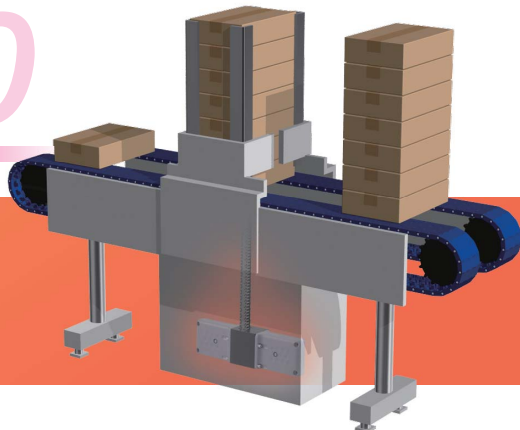

Cardboard stacker

Pg. 10

# Mixer and Roller

Dough is made using a machine called a mixer that stirs wheat flour, water, salt, and other ingredients. A roller is used in the process that spreads this dough into a thin sheet. The dough is spread gradually to make springy noodles. Tsubaki's reducers are used to drive mixers and rollers as our reducers can satisfy a wide range of needs.

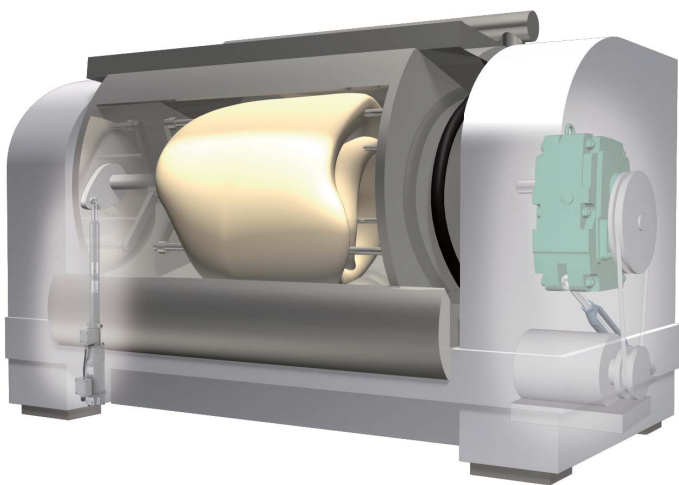

Mixer

## Shaft-mounted reducer

Our parallel shaft reducer can be installed in equipment with limited space thanks to its industry leading compact design.



Helical shaft-mounted reducer

## Small size gear motor



Various gear motors are used in the drive of the roller that spreads noodles in a thin sheet.

### Hypoid motor

- The orthogonal hollow shaft saves space.
- A wide variety to support high efficiency and high reduction ratios.

### Croise motor

- A worm gear is used to achieve durability and silent operation.

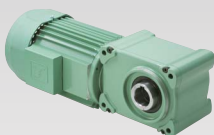

Hypoid motor

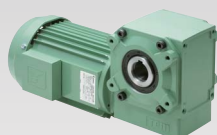

Croise motor

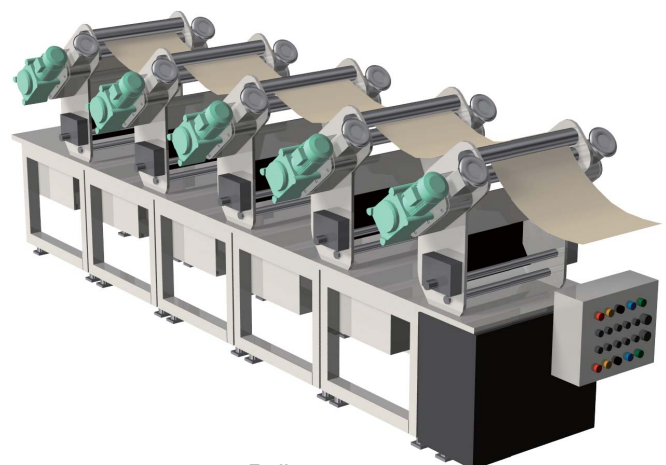

Roller

# Steamer

Thinly cut noodles are passed through a steamer. Because the steamer contains a hot and steamy atmosphere close to 100°C, various stainless steel small size conveyor chains are used against high temperature and corrosion.

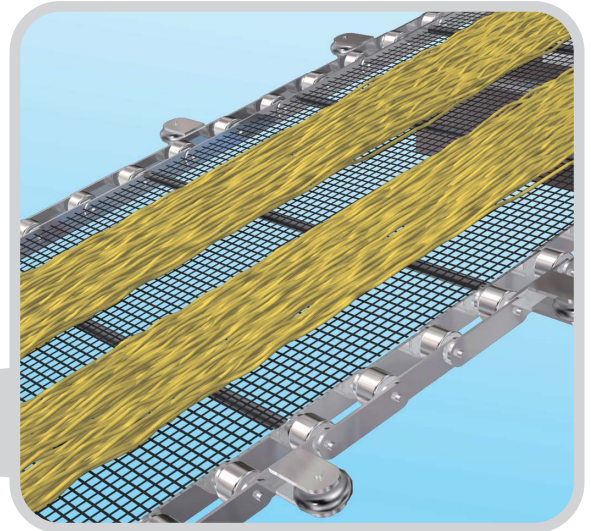
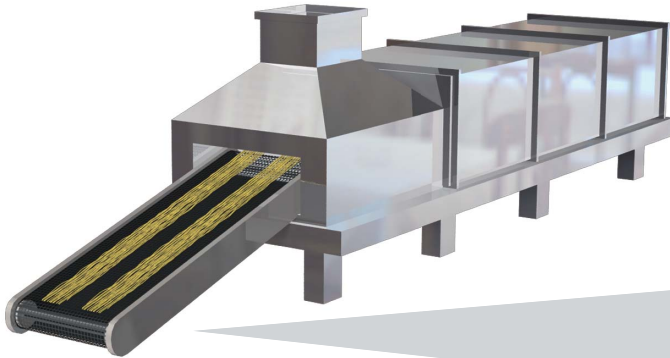

## LSK Series



Special wear-resistant, engineering plastic bushes reduce wear elongation, extend life and reduce initial elongation of the chain.

Lower replacement costs thanks to longer chain life cycle before replacement

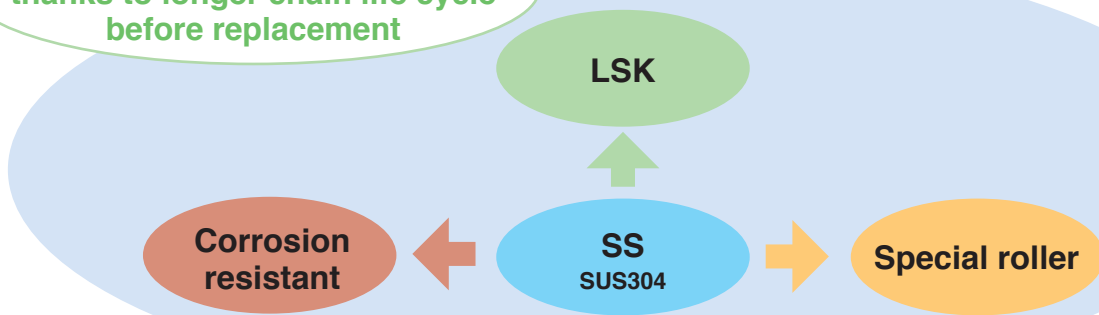

## Anti-stress corrosion cracking

Problems resulting from stress corrosion cracking can be prevented by changing chain materials.

- NS Series (SUS316)
- Special SUS

## Special roller

Use of special specification rollers leads to lower friction resistance and significantly reduced chain load.

- KV plastic rollers
- Special SUS rollers

# Fryer

To make fried noodles, steamed noodles are fed in chop off dies one serving at a time and fried in oil. Here you'll find Tsubaki Double Pitch Chains as well Lini Power Jacks to open and close the lid during equipment wash-downs, couplings, and Miter Gear Boxes being used.

## Jack Systems

Mechanically synchronized, accurate, and stable lifting equipment can be created by interlocking multiple jacks in an arrangement suited to the size of the lifter and the nature of the load. Tsubaki also offers a complete line-up of drive parts to select a jack system.



Couplings



Miter Gear Boxes



LINIPOWER® Jack(s)

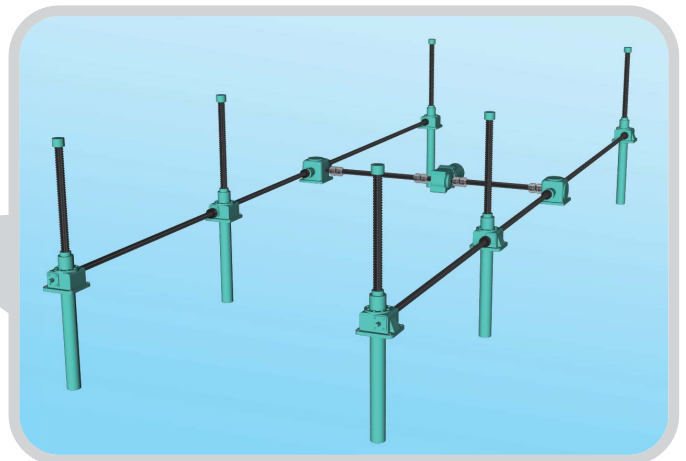

## Chains with Special Attachments (integrated attachments)

Special attachments can be attached to match the variety of jigs that are attached to the chain. This reduces installation and replacement man hours.

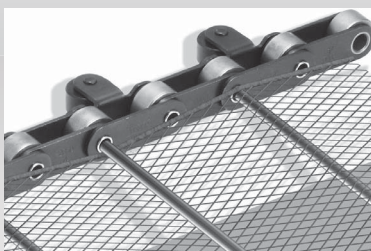

With stay pins

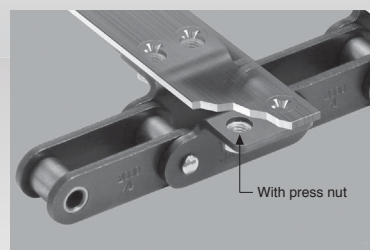

Press nut attachment

# Dryer

To make non-fried noodles, the noodles are not fried in oil but dried by hot air. Stainless steel and lube-free Lambda Chains are widely used to counter the high temperatures and corrosion resulting from washing.

## Corrosion Resistant Small Size Conveyor Chains

### KF Lambda Chain

KF Lambda Chain uses an oil-impregnated bush that withstands volatility and degradation even in normal to high temperature environments (especially from 150 to 230°C). This chain provides long life even in environments where additional lubrication is impossible. The special oil impregnated bushes use NSF-H1 certified oil for food conveyance.

### Lambda Stainless Steel Chain

Stainless steel chains are also available to prevent rusting on chain plates due to moisture generated from noodles in the drying process.

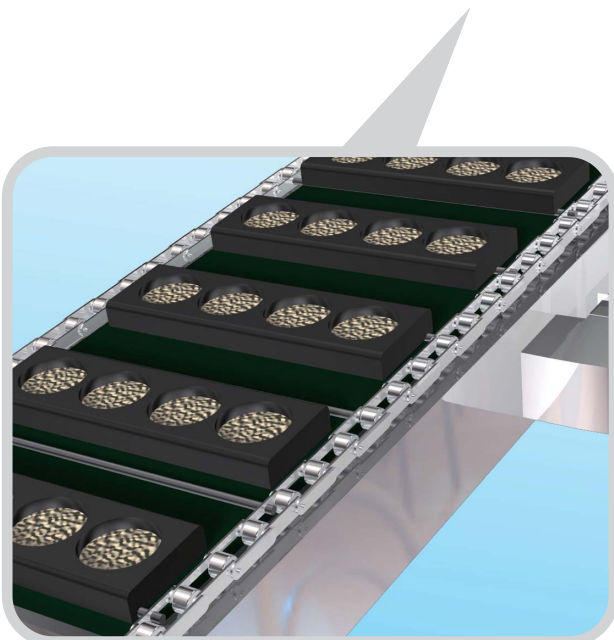

## Shock Monitor

Tsubaki's Shock Monitor, a power monitoring electrical overload protector, can detect even a subtle load change caused by lack of chain lubrication, which can alert you to insufficient lubrication and lubrication timing.



# Accumulator

An accumulator retains workpieces to accurately put noodles into cups after the dryer and cooler and to prevent stopped production in a previous process even in the case of a failure in a later process.

## LAMBDA® Chain



It is difficult to add lubricant to an accumulator because the machine is located close to products. With LAMBDA® Chain, special oil impregnated bushes use NSF-H1 certified oil for use on food equipment as standard specifications, contributing to food safety.

### Basic Lambda Chain construction

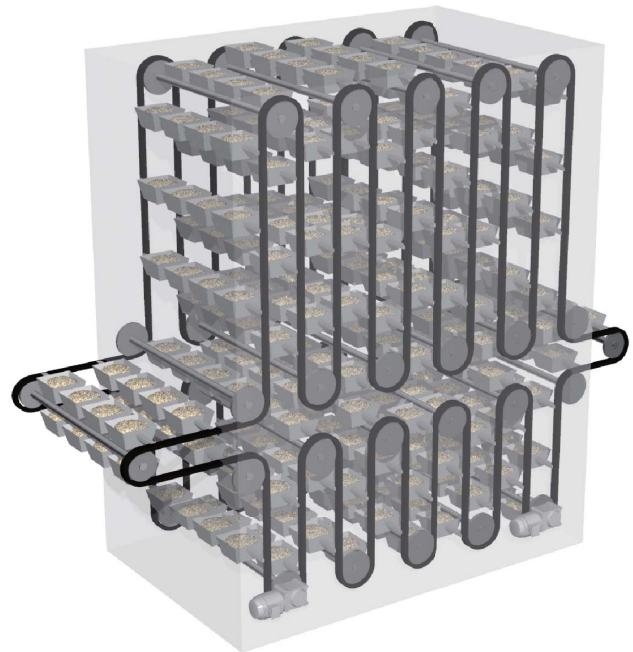
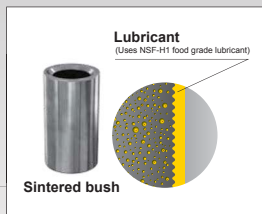
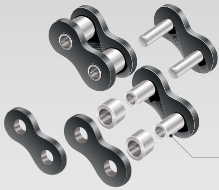

Patented (JP, US, CN)

## Sprocket with Wear Limit Marks for the Food Industry

In some cases, the condition of chains is managed but not the condition of sprockets. Tsubaki's sprocket with wear limit marks shows wear limits on the tooth profile (with drilled holes and special ink coloring) so that you can see wear conditions at a glance. These marks are also helpful for understanding the replacement timing, reducing maintenance man hours and extending chain life.

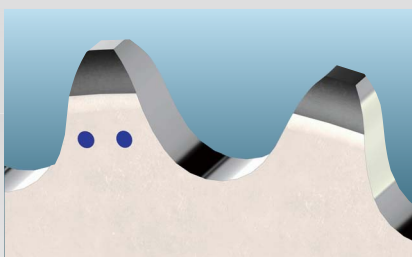

Conditions of a new sprocket

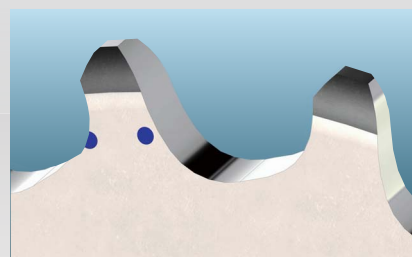

Worn conditions



# Cup Filling Machine

The process to fill cooked noodles into cups requires high precision indexing operation to fill them accurately, one serving at a time. Tsubaki's Bearing Bush Chain is ideal for this operation. Our lube-free, long life X-Lambda Chain is also used because the cup filling machine is long and located near products.

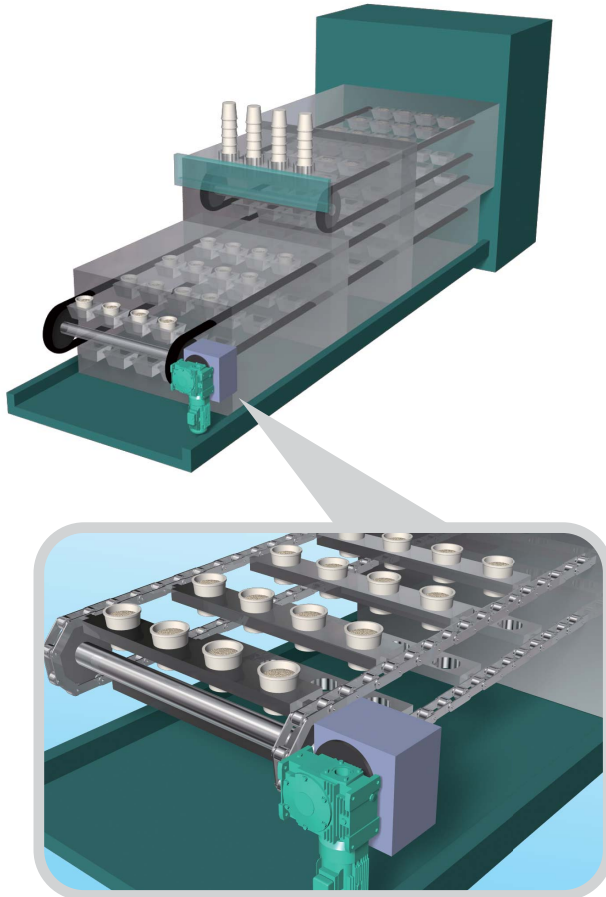

## Bearing Bush Chain

Needle bearings are installed between pins and bushes. This specification produces very little wear elongation and is ideal for indexing operations that requires high precision positioning.

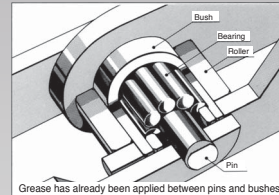

## Long Life Lambda Chain (X-Lambda)

Patented (JP, US, GB, DE, FR, IT, CN, KR, TW, HK)

Special oil impregnated felt seals suppress wear elongation significantly, which is effective in preventing mispositioning due to an elongated chain and extending chain life.



## MYDEX® Indexers and Worm Gear Reducers

Indexing operation is required in the process to attach top lid seals to the cups. Tsubaki's MYDEX Indexer, a high precision, high rigidity cam-type indexing drive unit uses worm reducers and high precision gears, making them perfect for this operation. We also offer TERVO Series electric servomotor reducers, which can be mounted easily when a servomotor is used.

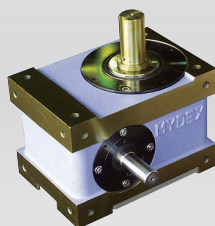

Indexer



Worm Power Drive®

# Transfer

To convey packaged products and cardboard boxes, Plastic Modular Chain is used as it is easier to use than belt conveyors.

## Plastic Modular Chain

Compared to a belt conveyor:

- Reduced snaking and slippage due to sprocket driving.
- Link structure makes partial repair possible and maintenance easy.
- Workpieces are less prone to damage thanks to lower friction.
- Higher wear resistance and longer life without deterioration such as frayed ends.

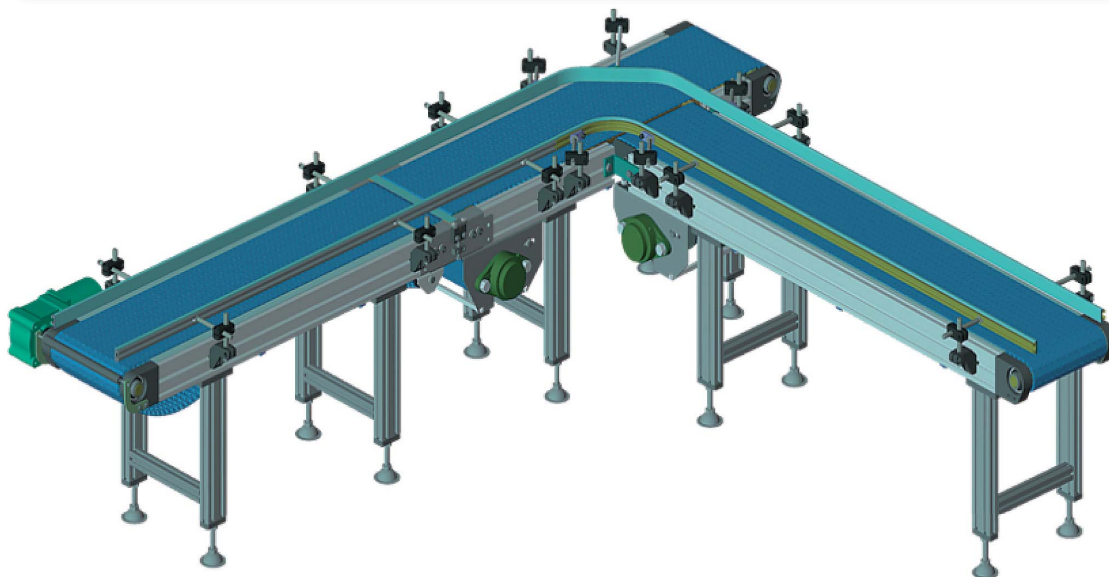
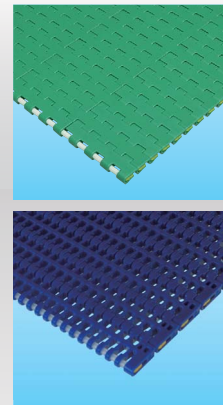

## Reducers for Food Applications

- Antimicrobial coating to protect from germs.
- NSF-certified H1 grease is used to contribute to food safety.



Hypoid motor  
for food applications

# Other

In addition, we also offer the Tsubaki original linear actuator, Zip Chain Actuator and new reducers specialized for lightweight conveyors.

## ZIP CHAIN ACTUATOR®



Our unique structure uses two chains to offer the following advantages compared to conventional pneumatic and hydraulic cylinders:

- Unparalleled space savings
- Energy savings
- High speed and multi-point stopping
- Free mounting direction

Thanks to the above features, this linear actuator is used in a wide variety of applications.

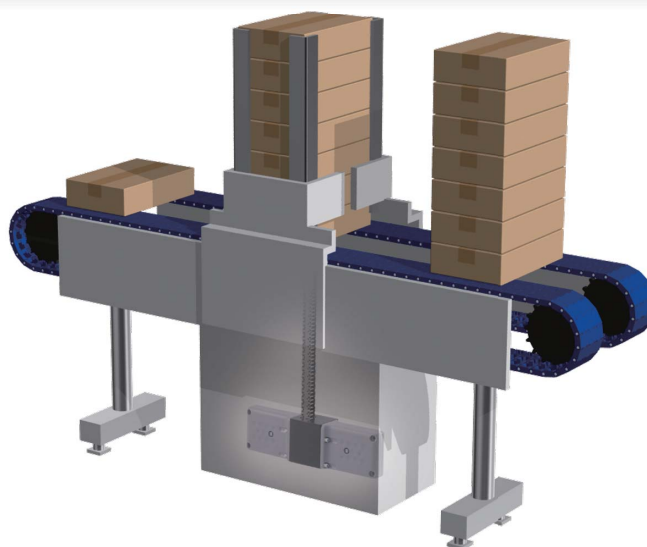

## AXIA MOTOR

Launching April 2017

Design application pending

A new orthogonal hollow gear motor specialized for lightweight conveyors

- Cost effective
- Pocket structure less prone to grease leakage
- Light weight and compact size specifically designed for conveyors
- In addition to the standard 25-mm diameter hollow shaft, an optional 30-mm bore diameter is also available.



AXIA MOTOR



# Tsubaki Group Website TSUBAKI TT-net Technical Information Website



We launched our comprehensive technical information website, TT-net, on April 8, 2013.

▶ **TT-net:** <https://tt-net.tsubakimoto.co.jp/tecs/top/index.asp?lang=en>

▶ **Tsubaki Group's website:** <http://tsubakimoto.com/>

## Tsubaki Group Network

# Tsubaki's Global Network

Tsubaki Group's extensive network,  
both for manufacturing and sales,  
supports your business in real time even outside Japan.  
(As of April 1, 2016)



● Production centers in Japan ● Tsubaki Group's manufacturing and sales companies outside Japan ● Tsubaki Group's sales companies outside Japan

<b>Production centers in Japan (11 plants)</b>	Kyotanabe Plant	Saitama Plant
	Tsubaki E&M Co., Kyoto Plant	Hyogo Plant
	Tsubaki E&M Co., Okayama Plant	Tsubakimoto Mayfran Inc.
<b>North and South America (10 companies)</b>	U.S. Tsubaki Holdings, Inc.	Tsubaki of Canada Limited
<b>Europe (18 companies)</b>	Tsubakimoto Europe B.V.	Tsubaki Kabelschlepp GmbH
	Tsubakimoto U.K Ltd.	Mayfran Limburg B.V.
<b>Asia and Oceania (28 companies)</b>	Taiwan Tsubakimoto Co.	Tsubakimoto Automotive (Shanghai) Co., Ltd.
	Tsubakimoto Chain (Tianjin) Co., Ltd.	Tsubaki E&M (Shanghai) Co., Ltd.
	Tsubakimoto Singapore Pte. Ltd	Tsubaki Australia Pty. Limited



## TSUBAKIMOTO CHAIN CO.

### Headquarters

Nakanoshima Mitsui Building  
3-3-3 Nakanoshima, Kita-ku  
Osaka 530-0005, Japan  
Phone : +81-6-6441-0011  
URL : <http://tsubakimoto.com/>



The Tsubaki Eco Link logo is used only on products that satisfy the standards for environmental friendliness set by the Tsubaki Group.

Note: In accordance with the policy of TSUBAKIMOTO CHAIN CO. to constantly improve its products, the specifications in this catalog are subject to change without notice. The logos, brand names, or product names in this catalog are trademarks or registered trademarks of Tsubakimoto Chain Co. in Japan and other countries.